

GU Estimating Angles

22.5°, 30°, 45°, 60°, 90°, 180°

Activity:

- Draw a 10 cm base
- using the middle for the vertex draw a 90°, 45°, and 22.5° angle
- repeat for 30° and 60° in a different color

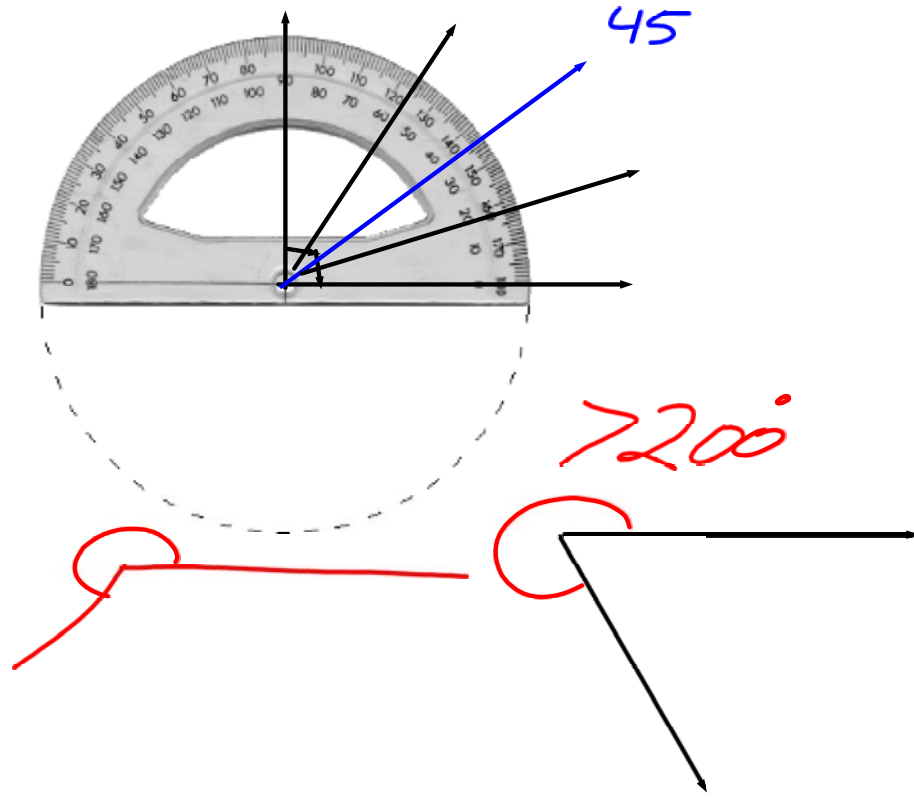
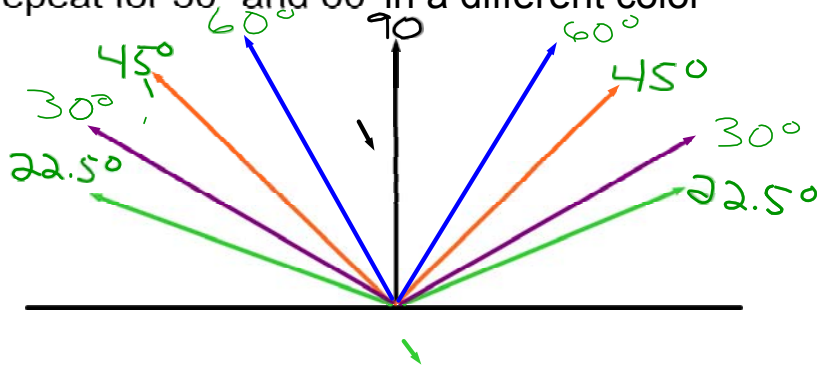

Together – Estimating Angles

Name _____

Date _____

①

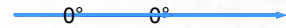
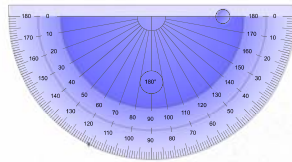
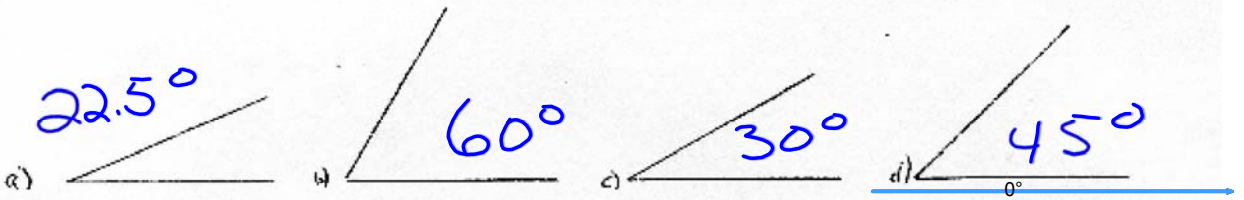

③

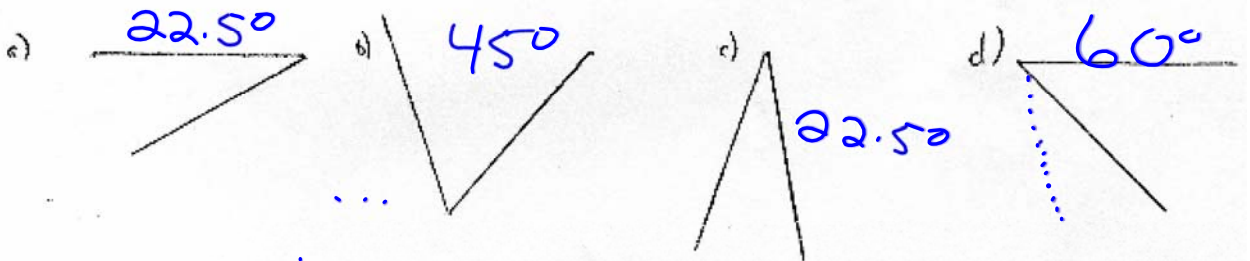

②

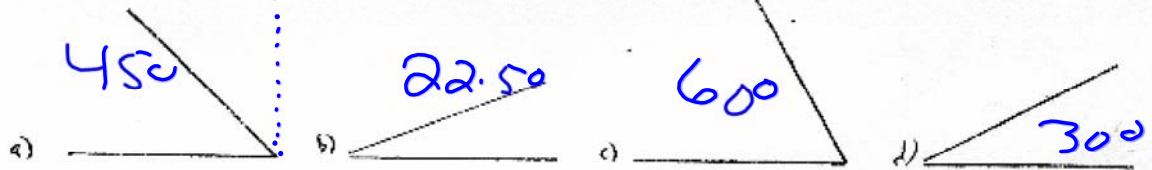

Assignment: Estimate Angles
need another assignment, Flash card matching?

Assignment – Estimating Angles
using your diagram only

Name _____

Date _____

①

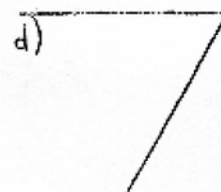
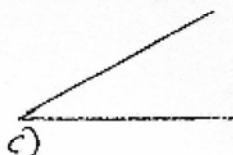
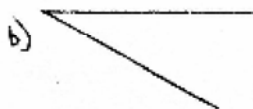
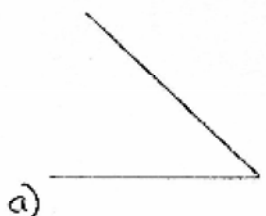

②

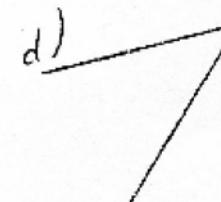
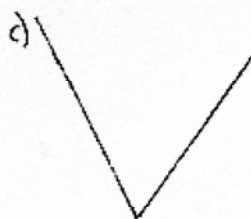
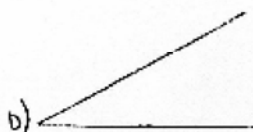
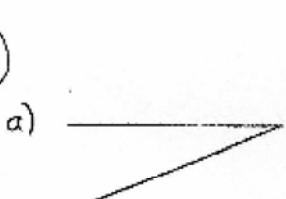

③

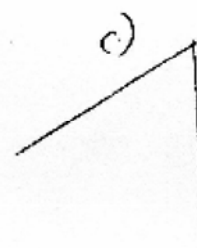
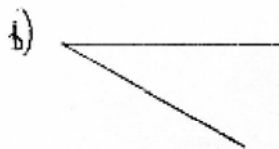
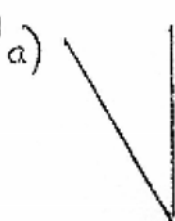

④

